

R630 PERGOMOVE



Peso medio
Medium Weight

Nozioni tecniche . Technical concepts

FUNZIONI . FEATURES

Protezione solare e da pioggia
Sun and rain protection

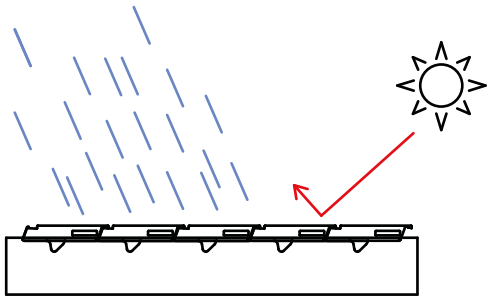

Parziale protezione solare e raffreddamento
Partial sun protection and cooling

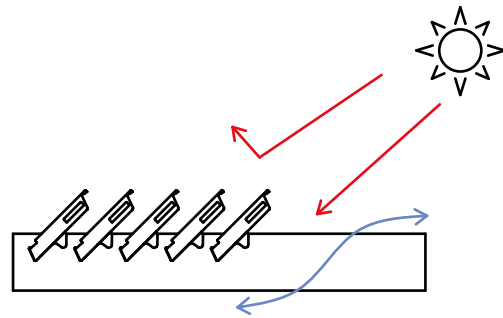

SCHEMA DI LETTURA . READING SCHEME

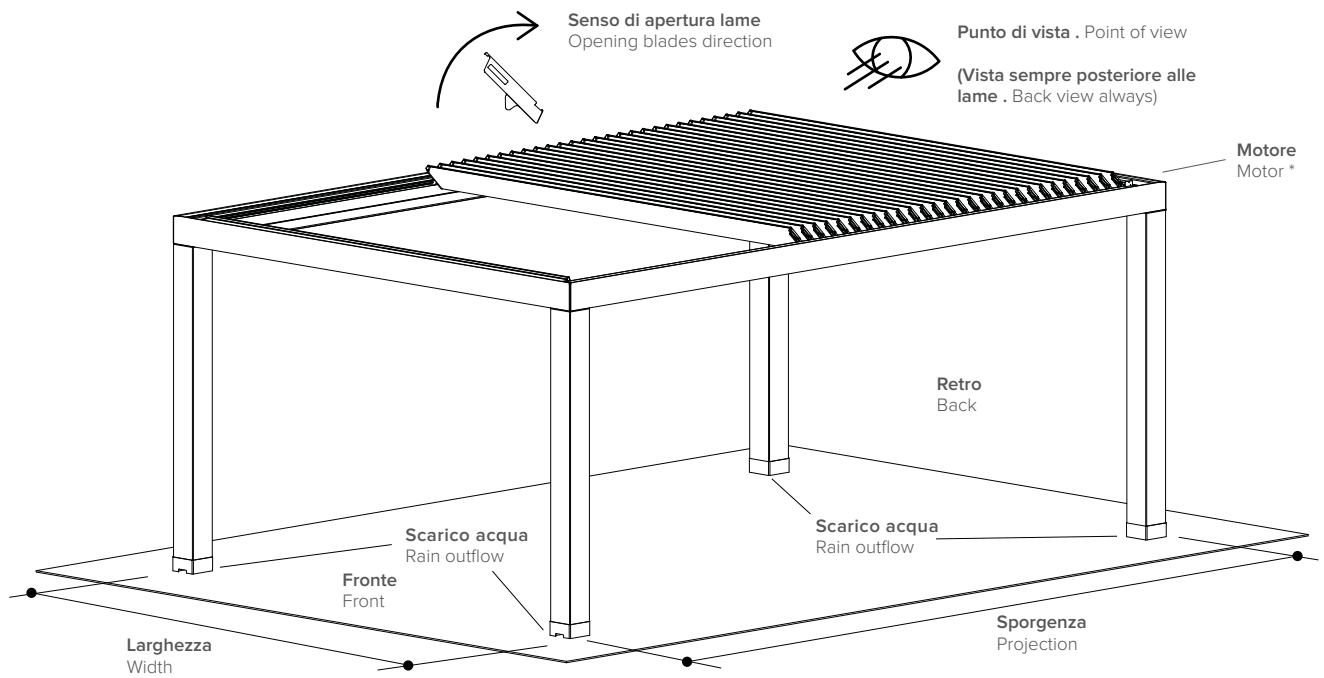

* Esempio di motore posizionato lato sinistro rispetto il punto di vista . Example of motor on the left side respect the point of view.



Configurazioni . Configurations

Quote espresse in mm . Dimensions in mm

AFFIANCAMENTO LATERALE . LATERAL ADJOINING

Per comporre il prezzo: dalla tabella prezzi R630 sommare ogni singolo modulo e sottrarre il numero di piantane in comune.
For price calculation: from price table R630 sum each module and deduct the number of common poles.

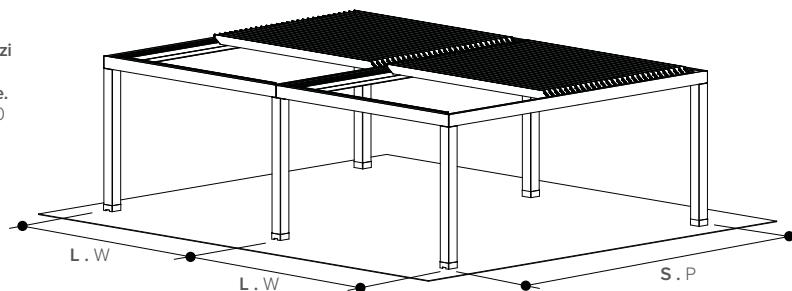

Lo schema rappresenta un affiancamento laterale con motori in posizione sinistra, ogni piantana permette lo scarico dell'acqua, comprese quelle in comune.
The diagram shows a lateral adjoining with motors on the left, each pole allows to drain water, including those in common.

Vista dall'alto . Top view

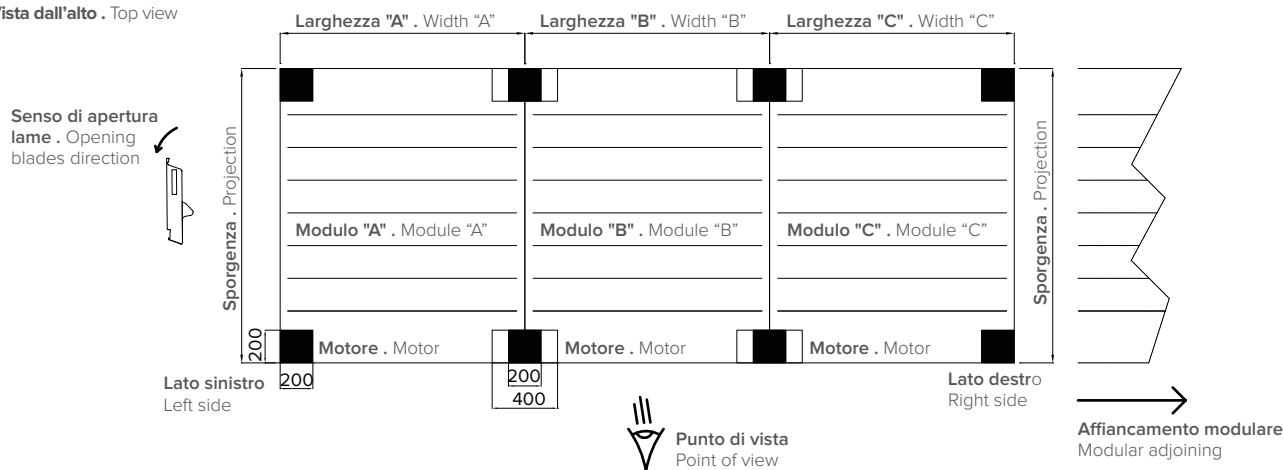

AFFIANCAMENTO FRONTALE . FRONTAL ADJOINING

Per comporre il prezzo: dalla tabella prezzi R630 sommare ogni singolo modulo e sottrarre il numero di piantane in comune.
For price calculation: from price table R630 sum each module and deduct the number of common poles.

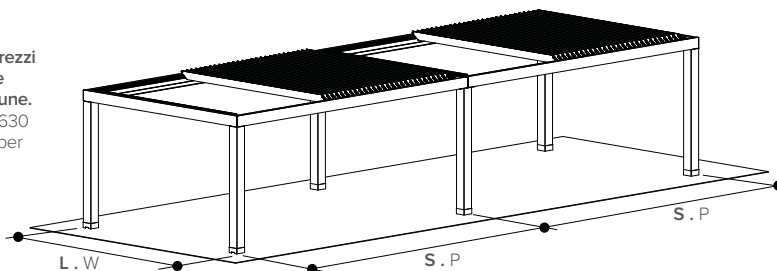

Lo schema rappresenta un affiancamento frontale con motori in posizione sinistra, ogni piantana permette lo scarico dell'acqua, comprese quelle in comune.
The diagram shows a frontal adjoining with motors on the left, each pole allows to drain water, including those in common.

Vista dall'alto . Top view

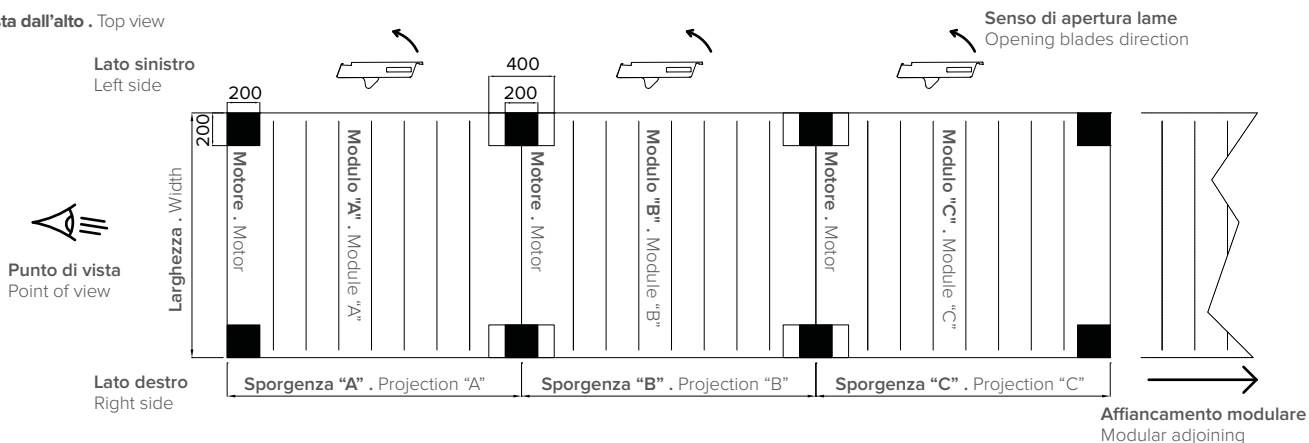

R630 PERGOMOVE

Dati tecnici . Technical data

Quote espresse in mm . Dimensions in mm

Vista frontale . Frontal view

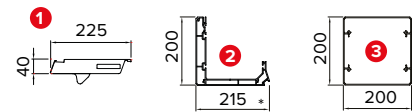
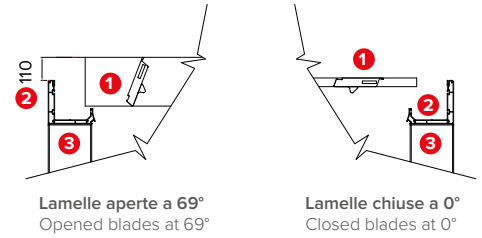
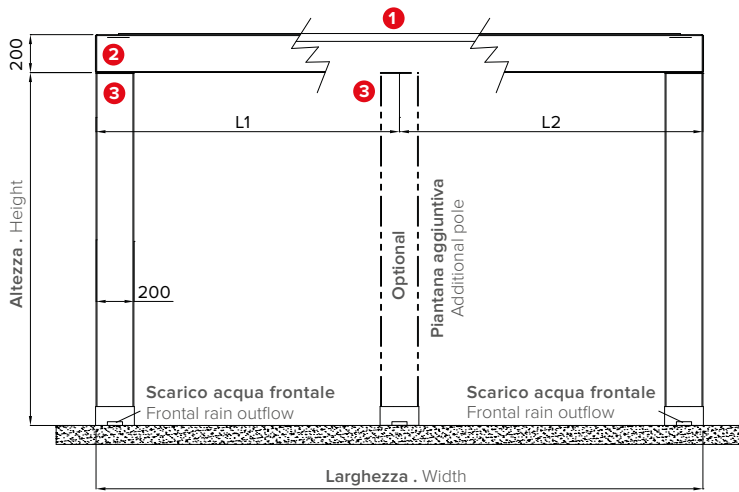

Vista laterale . Side view

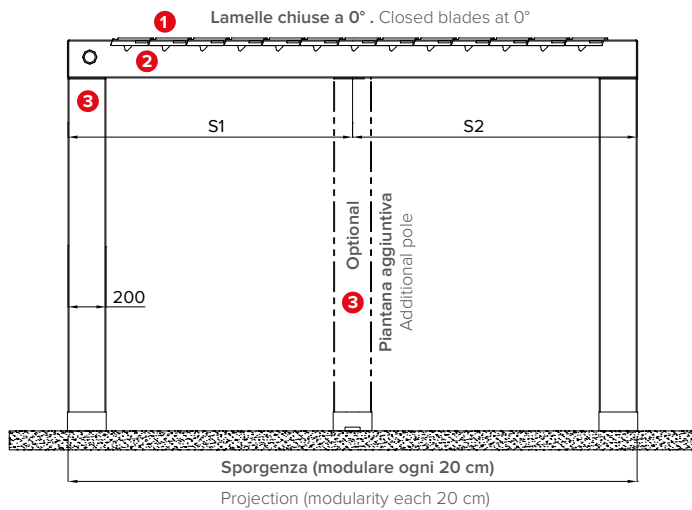

STANDARD

Piede a terra regolabile . Adjustable foot

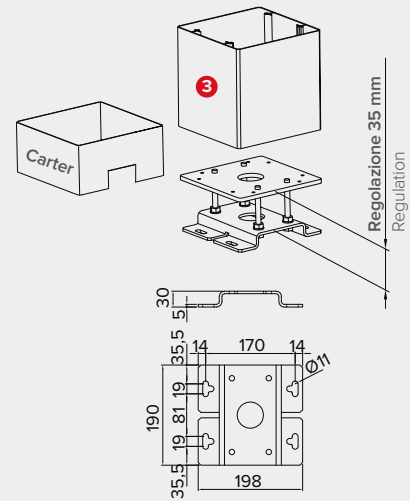

Altezza piantana 20 x 20 cm garantita, H 300 cm, oltre, chiedere fattibilità . Pole height 20 x 20 cm guaranteed, H 300 cm, beyond asking for feasibility.

Variante a richiesta con piantane 13x13 cm. per moduli singoli di larghezza 4 mt. per sporgenza 4 mt. massima (no piantana in comune).
Variation upon request with 13x13 cm poles for single forms of 4 mt. width by 4 mt. max. projection (no common pole).

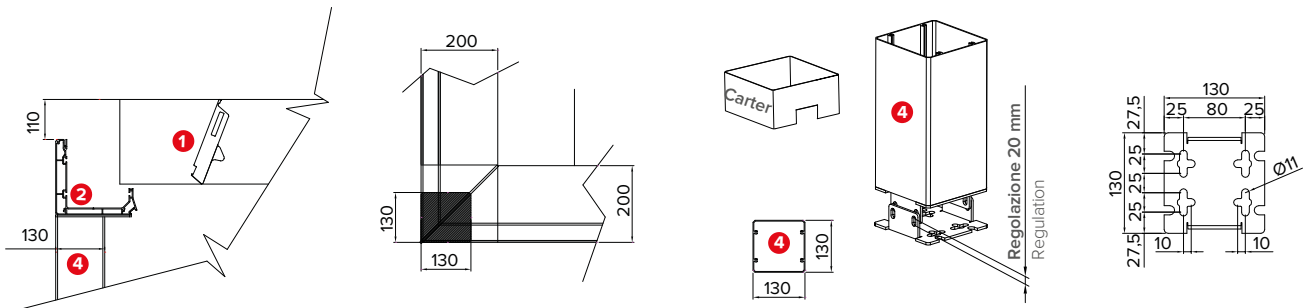

Altezza piantana 13 x 13 cm garantita, H 250 cm, oltre, chiedere fattibilità . Pole height 13 x 13 cm guaranteed, H 250 cm, beyond asking for feasibility.

* Sede per inserimento di luci LED . Seat for LED lights.

Sporgenza Projection	S cm	200	220	240	260	280	300	320	340	360	380	400	420	440	460	480	500	520	540	560	580	600
Lamelle Blades	n°	8	9	10	11	12	13	14	15	16	17	18	19	20	21	22	23	24	25	26	27	28
Impacchettamento Packing	X cm	64	68,5	73	77,5	82	86,5	91	95,5	100	104,5	109	113,5	118	122,5	127	131,5	136	140,5	145	149,5	154

R630 PERGOMOVE

Dettagli tecnici . Technical details

Quote espresse in mm . Dimensions in mm

Lame orizzontali estese . Extended horizontal blades

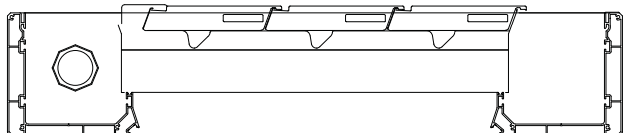

Apertura progressiva 30° . Progressive opening 30°

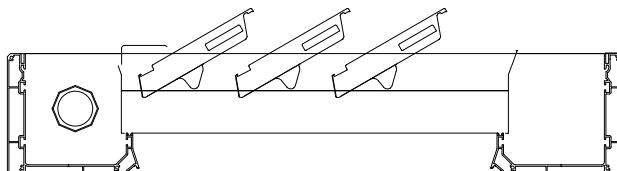

Apertura progressiva 45° . Progressive opening 45°

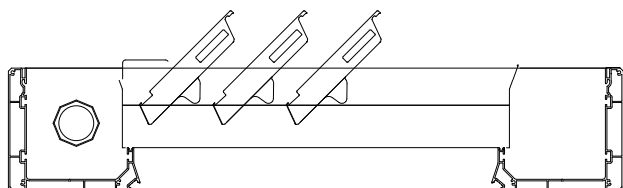

Apertura massima impacchettata 69° . Maximum packed opening 69°

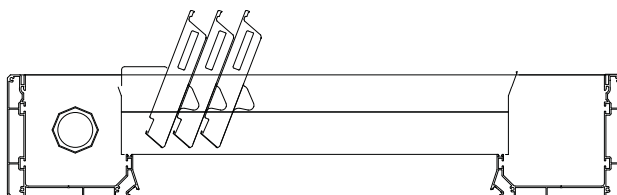

Le aperture indicate non sono fisse ma rappresentative del movimento progressivo e continuo di impacchettamento delle lame.

Possibilità di arrestare le lame in qualsiasi posizione intermedia tramite il pulsante stop del telecomando.

The openings indicated are not fixed but representative of the progressive and continuous movement of the blades.

Possibility to stop the blades in any intermediate position using the stop button on the remote control.

IMPACCHETTAMENTO . PACKING

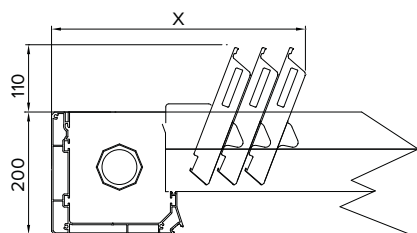

STANDARD

Carter laterali per paraschizzi . Side covers for splash guards

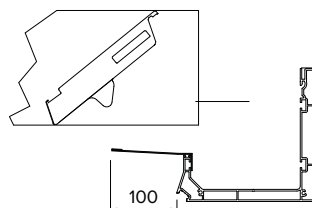

PIANTANA IN COMUNE PER MODULI AFFIANCATI . COMMON POLE FOR ADJOINED MODULES

Vista dall'alto . Top view

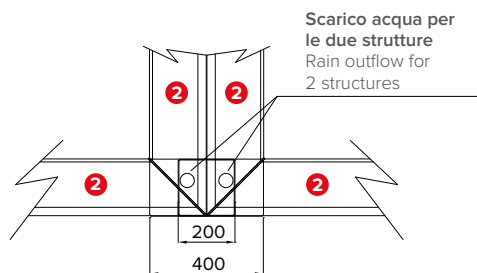

Vista laterale . Side view

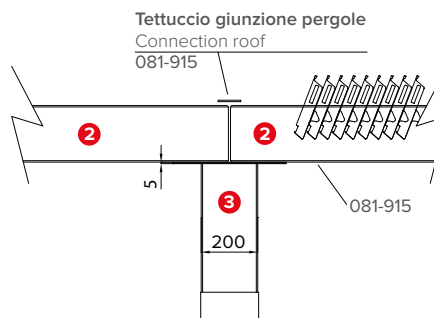

Art 081-915 di dimensioni 80x5mm consigliato anche come spessore di compensazione per eventuali chiusure perimetrali.
Art 081-915 of dimensions 80x5mm recommended as thick compensation for any perimetric closings.

Legenda tecnica . Technical legend

- ① Lamella . Blade
- ② Profilo gronda perimetrale . Perimetric water-drain profile
- ③ Piantana 20x20 cm . Pole 20x20 cm
- ④ Piantana 13x13 cm . Pole 13x13 cm

X Impacchettamento . Packing

Varianti
Variants
R630

R631 PERGOMOVE

Gronda addossata a parete . Wall installation water-drain

LAME PARALLELE AL MURO . BLADES PARALLEL TO THE WALL
Schema di esempio . Example scheme

Quote espresse in mm . Dimensions in mm

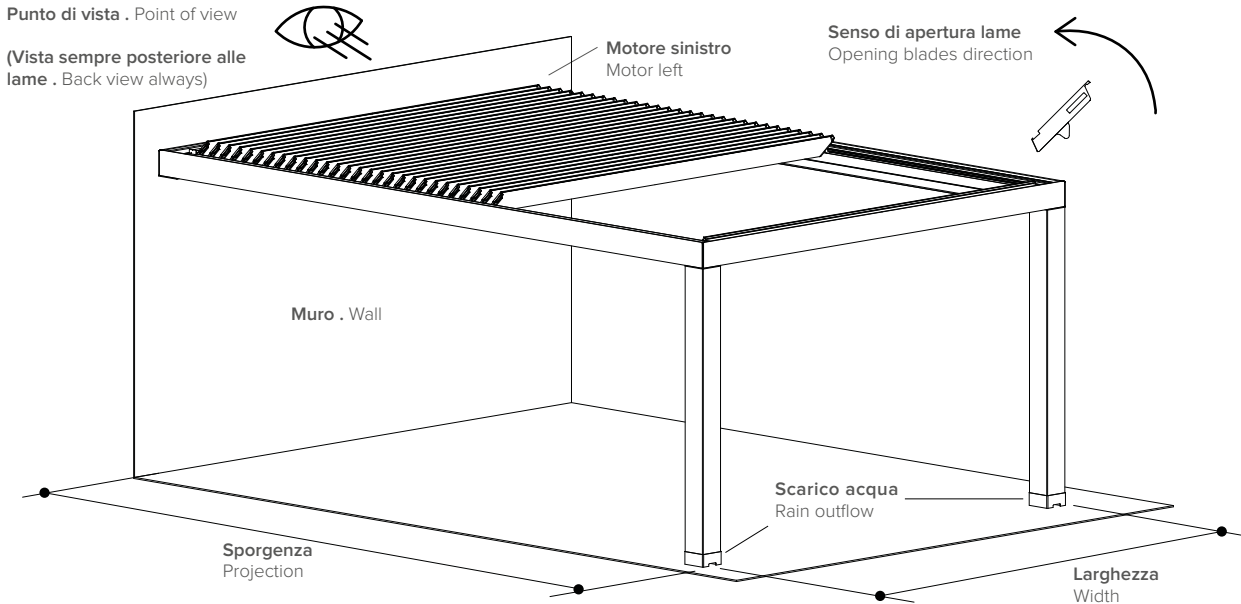

LAME PERPENDICOLARI AL MURO . BLADES PERPENDICULAR TO THE WALL
Schema di esempio . Example scheme

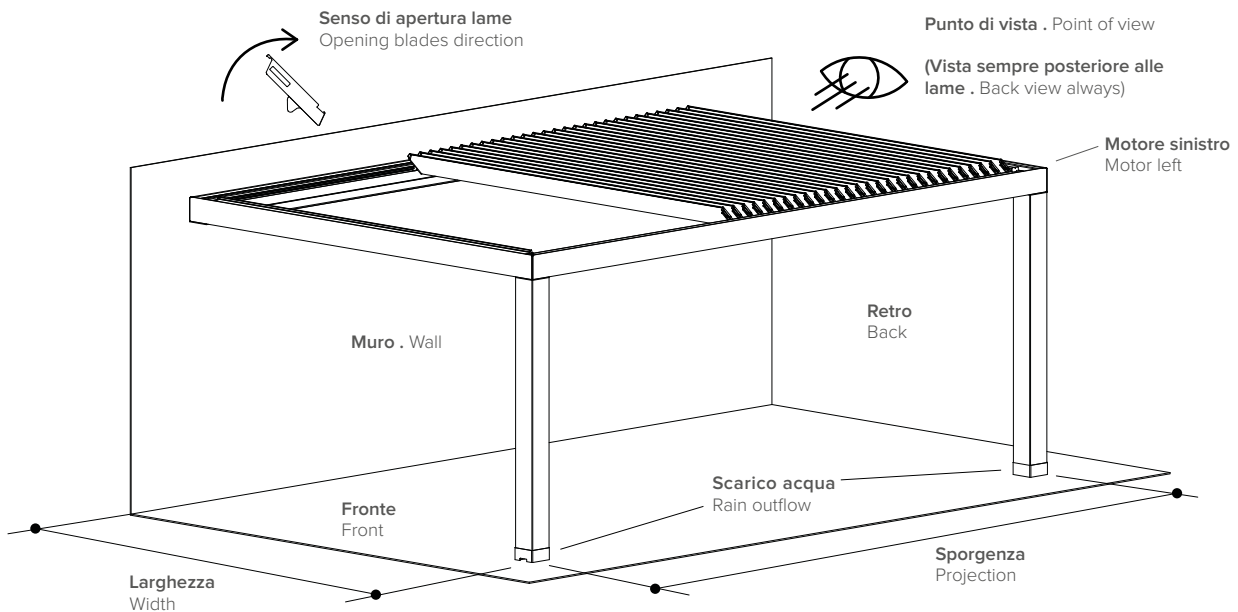

Schema di fissaggio . Fixation scheme

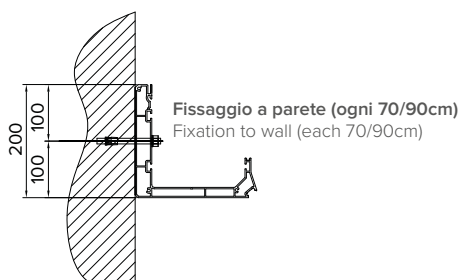

Senza piantane . Without poles

Quote espresse in mm . Dimensions in mm

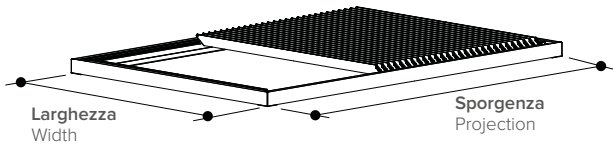

Sono necessari almeno 2 scarichi acqua . 2 rain outflow at least needed

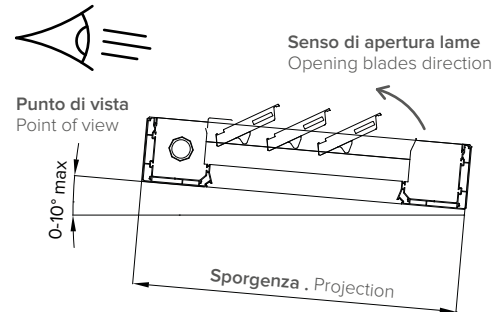

Inclinazione massima consentita per appoggio su strutture esistenti (Max 17 cm/mt.)
Max allowed inclination dor installation on structures (Max 17 cm/mt.)

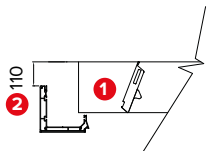

Lamelle aperte a 69°
Opened blades at 69°

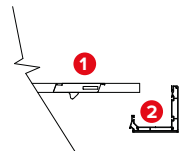

Lamelle chiuse a 0°
Closed blades at 0°

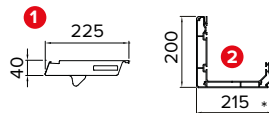

ATTENZIONE: non è possibile installazione completa della struttura addossata a tetti a vetro.
WARNING: it is not possible to install the structure against glass roofs.

* Sede per inserimento di luci LED . Seat for LED lights.

Legenda tecnica . Technical legend

- 1 Lamella . Blade
- 2 Profilo gronda perimetrale . Perimetric water-drain profile